

plug&play prewirings
position indicators
security systems
push buttons
intercoms
for lifts

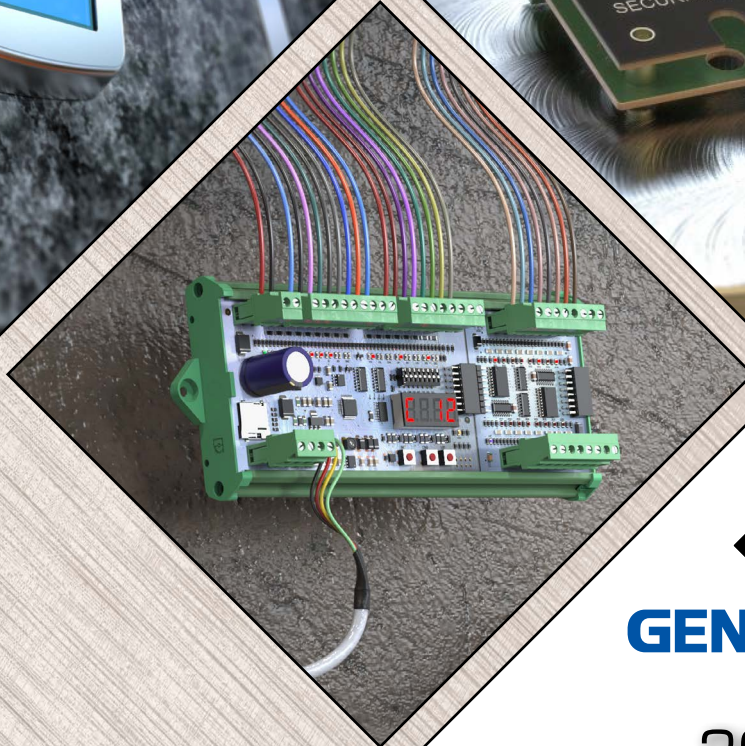

GENEMEK

2017
Product Catalogue

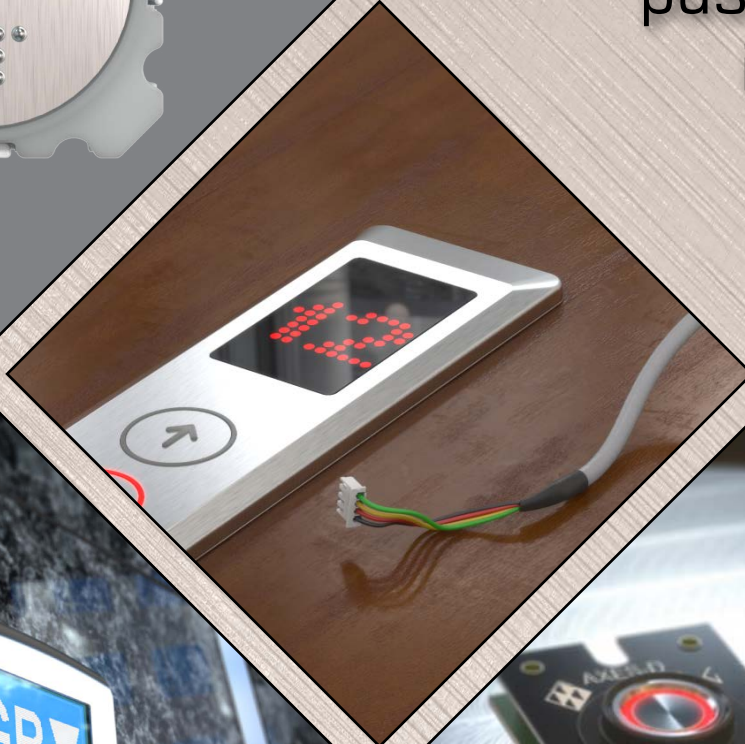

MOLD MAKING



MOLD MAKING



PLASTIC INJECTION



SHEET METAL PROCESSING



SHEET METAL PROCESSING



LASER CUTTING



MARKETING



MARKETING



ELECTRONIC ASSEMBLY LINE

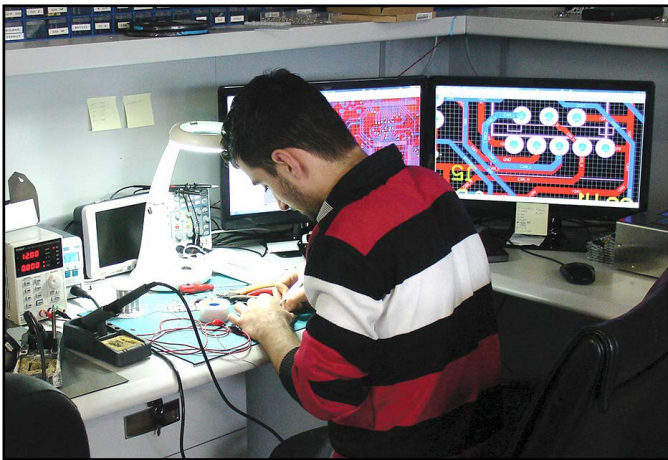

RESEARCH AND DEVELOPMENT

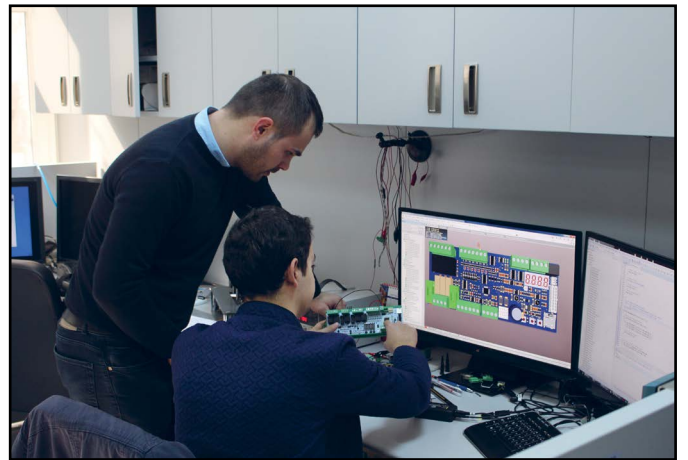

RESEARCH AND DEVELOPMENT

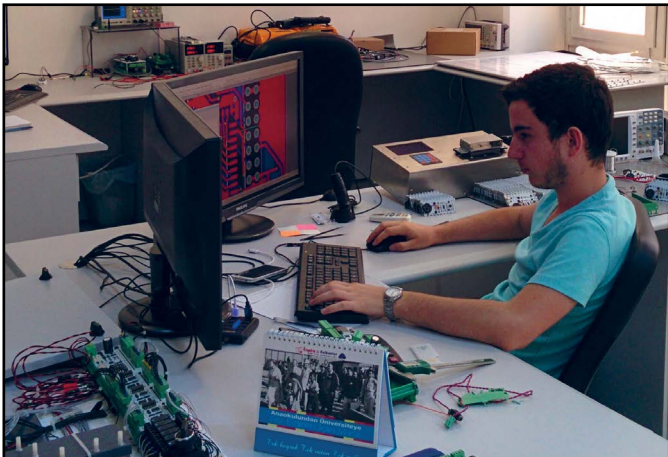

RESEARCH AND DEVELOPMENT

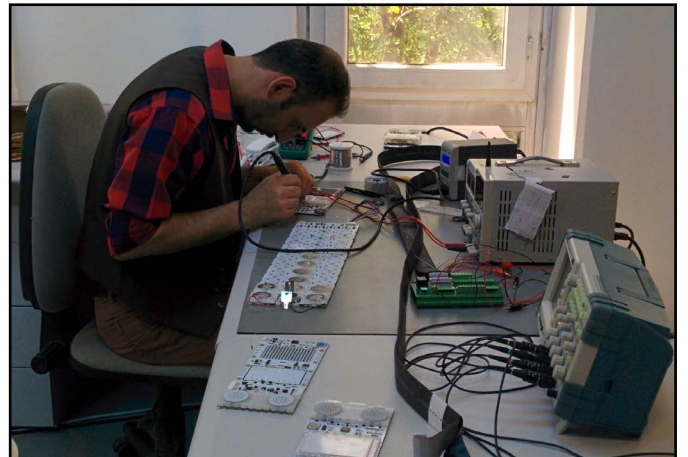

QUALITY CONTROL



INTERLIFT - AUGSBURG, GERMANY 2009



ASANSÖR İSTANBUL - ISTANBUL, TURKEY 2009



INEXLEX - IZMIR, TURKEY 2012



LIFTEXPO - MOSCOW, RUSSIA 2013



LIFTECH EXPO - CAIRO, EGYPT 2013



INTERLIFT - AUGSBURG, GERMANY 2013



INEXLEX - IZMIR, TURKEY 2014



EURO-LIFT - KIELCE, POLAND 2014

GENEMEK has been in operation in elevator industry since year 1999.

After 18 years of experience, We inspire, design, tool and assemble electronic and mechanical parts in-house.

- 2017** *high performance color TFT indicators*
- 2016** *new facility, LASER cutting / CNC bending*
- 2015** *new plastic injection molding machine facility*
- 2014** *CANBUS type rewiring solutions*
- 2013** *increased production capacity with full automatic SMT line*
- 2012** *In-house plastic Injection, hydraulic forming, tool making ability*
- 2011** *first heartbeats of 9.9mm surface mounted series AVOX*
- 2010** *tool making facility investments, CNC, EDM*
- 2009** *ability to design plastic injection molds, deep drawn parts*
- 2008** *first production of mechanical parts in-house*
- 2007** *solution provider for prewired installations*
- 2006** *moving into new building, surface mount technology investments*
- 2005** *rewiring systems for landing and car operator panels*
- 2004** *accumulator charging devices, two-wire position indicators*
- 2003** *programmable door chimes*
- 2002** *security device for elevators*
- 2001** *programmable LED - LCD position indicators*
- 2000** *infrared security curtain for automatic doors of elevators*
- 1999** *established to design and produce electromechanical parts*

INDEX



EPAC / FUSION COP 8-9

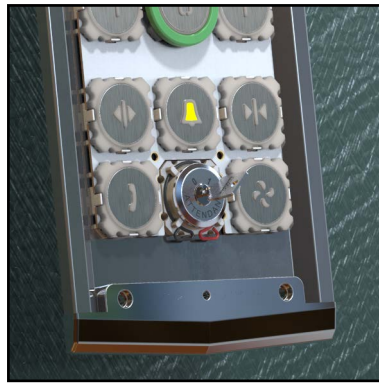

AVOX 7/9 COP 10-11



REDLINE COP 12-13



PROWIRED COP14-15



ARCODE 16-17

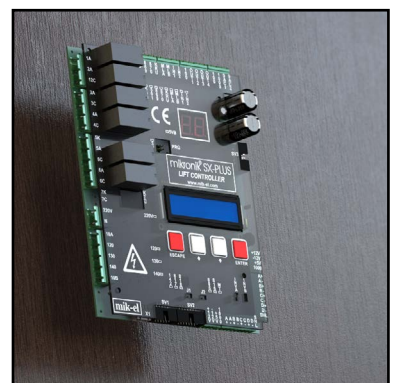

MiVOX18-19

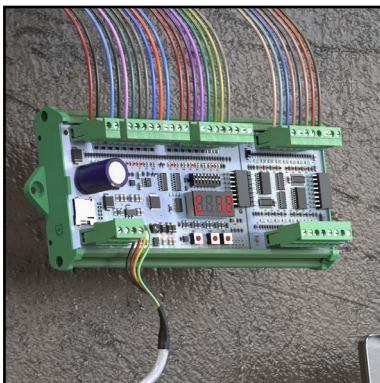

MS2 / GENCAN 20-21



color TFT 22-23

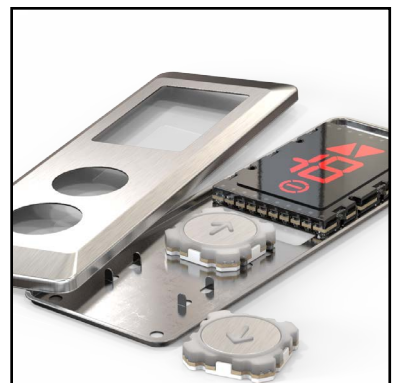

REDLINE LOP 24-25

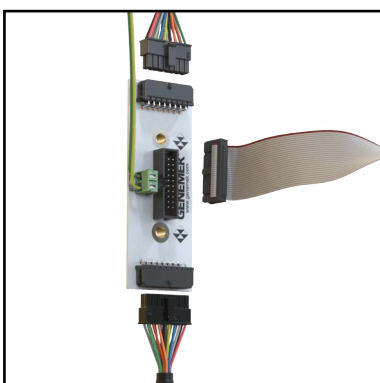

PROWIRED LOP 26-27

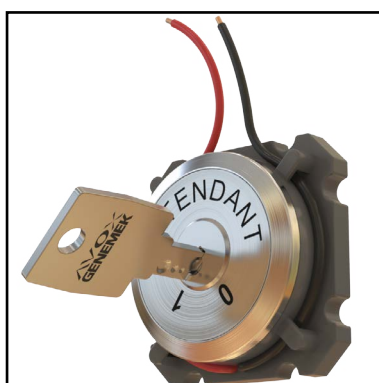

components 28



specials 29

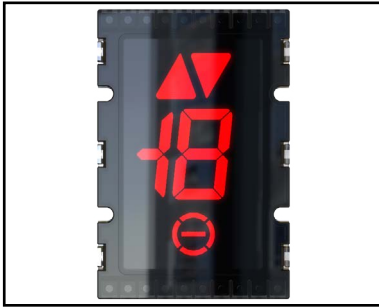

position indicators 30



push buttons 31

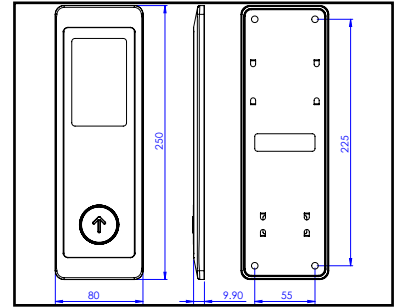

dimensions 32

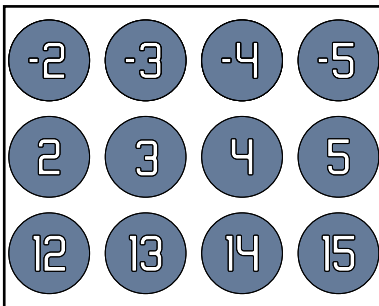

available figures 33



MONO & HERA COP 34-35



RAM 36



intercom 37

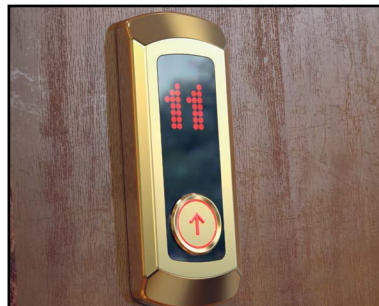

ARENA 38-39



RACE 40-41



MONO LOP 42-43



ECO 44-45



QUAD 46-47

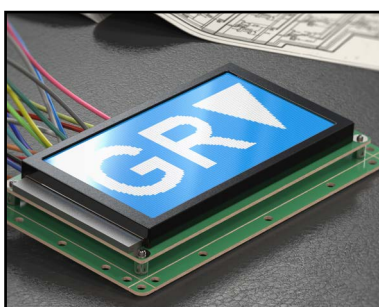

LCD graphics 48-49

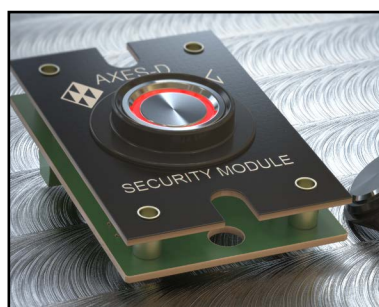

AXES-D 50

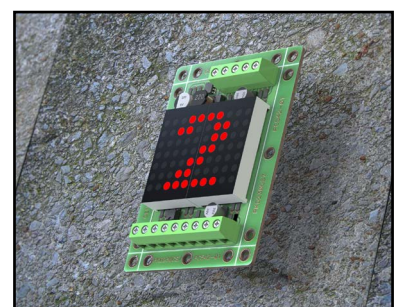

LED dot-matrix 51

EPAK premium



FS952

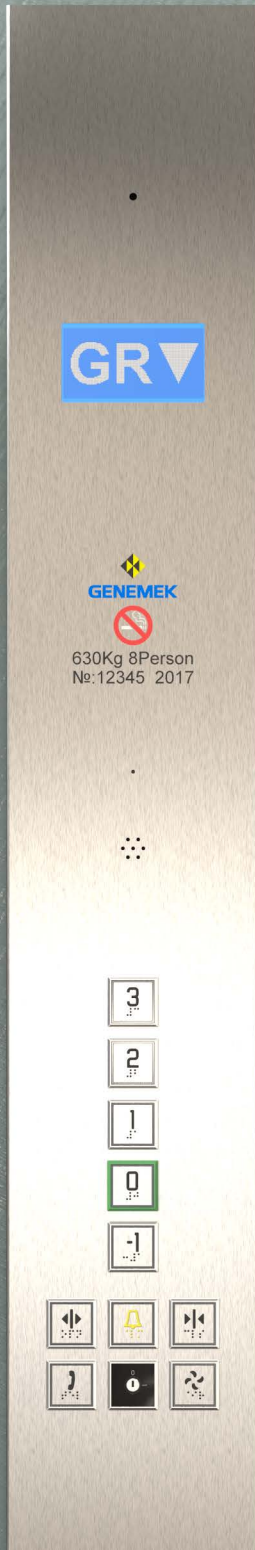

EP931



EP932



630Kg 8Person
No: 12345 2017

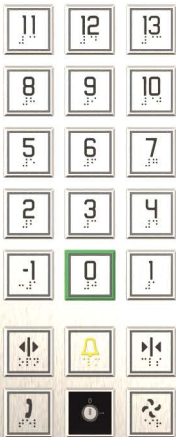

EP933

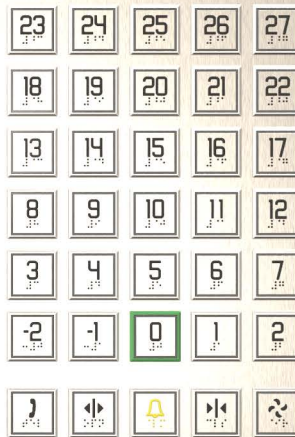

EP955



EP954

AVOX 7 series

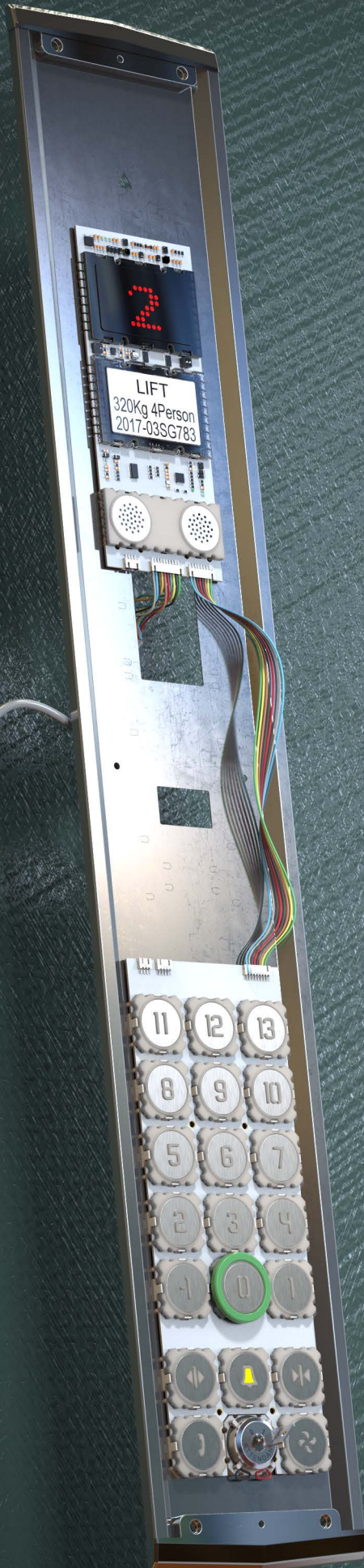

731.CDD



732.CDD



733.CDD

COMPATIBILITY

HY - HYUNDAI
 SV - STEP F5021 AS380
 LS - LISA/SCHNEIDER
 CP - CANOPEN DSP417
 GV - GENCAN
 AC - ARKEL ARCODE
 MT - ARKEL MOTCODE
 MV - MIKEL MIVOX
 NF - NIDEC FUSION
 RL - REDLINE
 PW - PARALLEL PREWIRED
 AF - ARKEL ARL500

KEYBOARD TYPE

31 - 2 TO 5 STOPS
 32 - 6 TO 10 STOPS
 33 - 11 TO 15 STOPS
 3F - DIALPAD (-9 TO 99)
 54 - 16 TO 24 STOPS)
 55 - 25 TO 30 STOPS)

GV932.CDD

SIZE

7 - HALF HEIGHT 1100mm
 9 - FULL HEIGHT 2150mm

INDICATOR TYPE

CDD - 16x10 LED MATRIX
 CT4 - 4,3" COLOR LCD
 PT7 - 7,0" MULTIMEDIA LCD
 PT10 - 10,1" MULTIMEDIA LCD
 DSC - PARALLEL 7-SEGMENT
 CSP - PARALLEL 7-SEGMENT PREWIRED

AVOX 9 series

3

LIFT
320Kg 4Person
2017-03SG783



GENEMEK
1000Kg 12 Person
PASSENGER ELEVATOR
EN81-1+A3
Serial Nr: S282Y16
Mfg Year: 2017
CE
9999

4
3
2
1
0



931.CDD

9

LIFT
320Kg 4Person
2017-03SG783



GENEMEK
1000Kg 12 Person
PASSENGER ELEVATOR
EN81-1+A3
Serial Nr: S282Y16
Mfg Year: 2017
CE
9999

7 8
5 6
3 4
1 2
-1 0



932.CDD

10

LIFT
320Kg 4Person
2017-03SG783



GENEMEK
1000Kg 12 Person
PASSENGER ELEVATOR
EN81-1+A3
Serial Nr: S282Y16
Mfg Year: 2017
CE
9999

11 12 13
8 9 10
5 6 7
2 3 4
-1 0 1



933.CDD

16

LIFT
320Kg 4Person
2017-03SG783



GENEMEK
1000Kg 12 Person
PASSENGER ELEVATOR
EN81-1+A3
Serial Nr: S282Y16
Mfg Year: 2017
CE
9999

18 19 20 21
14 15 16 17
10 11 12 13
6 7 8 9
2 3 4 5
-2 -1 0 1



954.CDD

24

LIFT
320Kg 4Person
2017-03SG783



GENEMEK
1000Kg 12 Person
PASSENGER ELEVATOR
EN81-1+A3
Serial Nr: S282Y16
Mfg Year: 2017
CE
9999

23 24 25 26 27
18 19 20 21 22
13 14 15 16 17
8 9 10 11 12
3 4 5 6 7
-2 -1 0 1 2



955.CDD

REDLINE COP



RL731.DSC



RL732.DSC



REDLINE COP

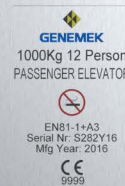
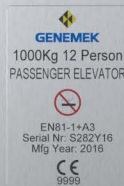

RL931.DSC

RL932.DSC

PROWIRED COP

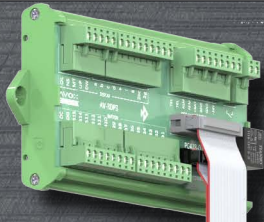

ready to plug

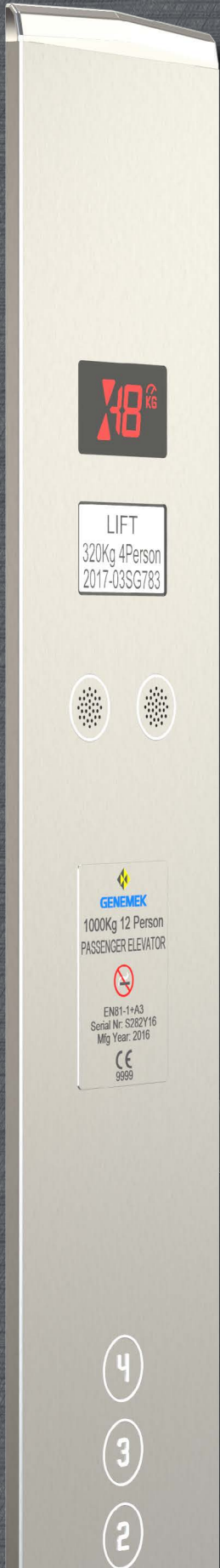

LIFT
320Kg 4Person
2017-03SG783



GENEMEK
1000Kg 12 Person
PASSENGER ELEVATOR
EN81-1+A3
Serial Nr: S282Y16
Mfg Year: 2016
CE
9999

4

3

2



PW 731



PW 732



PW 733

PROWIRED COP



LIFT
320Kg 4Person
2017-03SG783

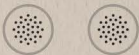

GENEMEK
1000Kg 12 Person
PASSENGER ELEVATOR
EN81-1+A3
Serial Nr: S282Y16
Mfg Year: 2017
CE 9999



PW 731



LIFT
320Kg 4Person
2017-03SG783

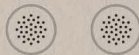

GENEMEK
1000Kg 12 Person
PASSENGER ELEVATOR
EN81-1+A3
Serial Nr: S282Y16
Mfg Year: 2017
CE 9999



PW 732



LIFT
320Kg 4Person
2017-03SG783



GENEMEK
1000Kg 12 Person
PASSENGER ELEVATOR
EN81-1+A3
Serial Nr: S282Y16
Mfg Year: 2017
CE 9999

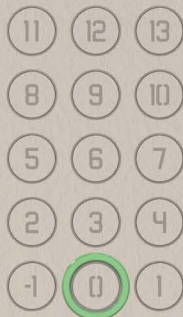

PW 733



plug&play ARCODE



plug&play ARCODE



AC4110



AC41B0



AV1202

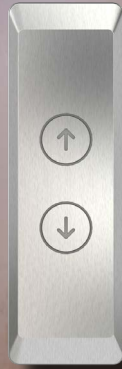

AV2202



AC1012



AC2012



AC1072



AC2072

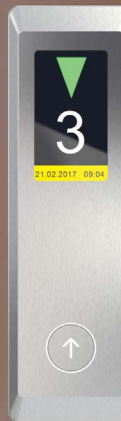

AC10B2

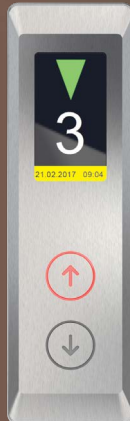

AC20B2



AC1022



AC2022



AC1082



AC2082

plug&play MiVOX

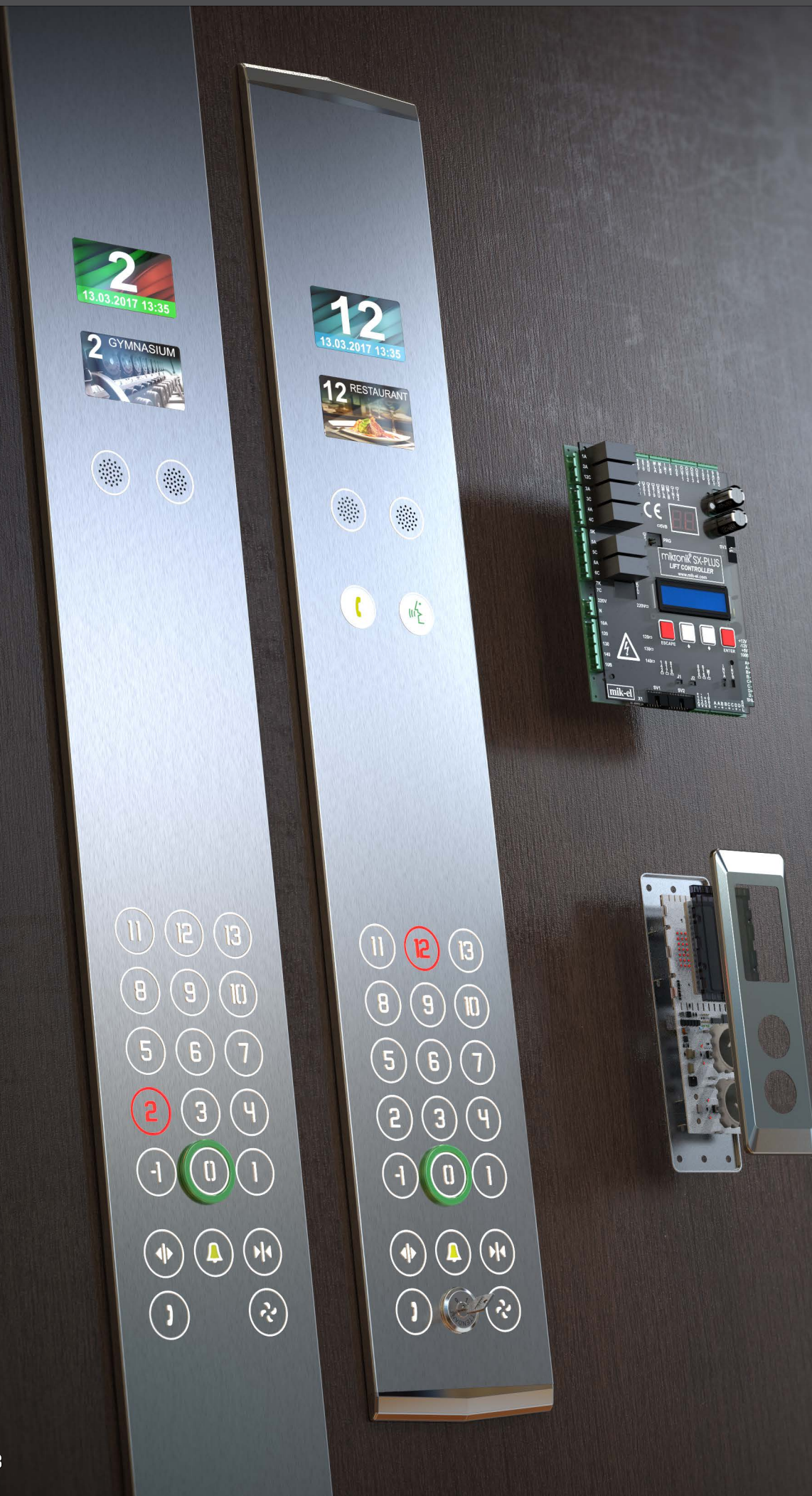

plug&play MiVOX



MV4110



MV41B0



AV1202



AV2202



MV1012



MV2012



MV1072



MV2072

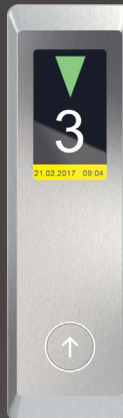

MV10B2

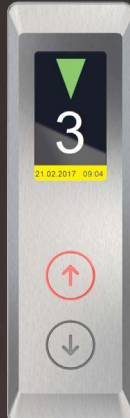

MV20B2



MV1022



MV2022

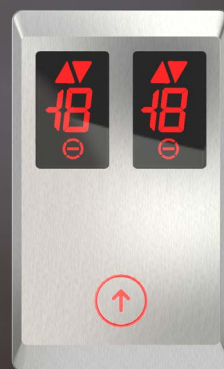

MV10B2



MV20B2

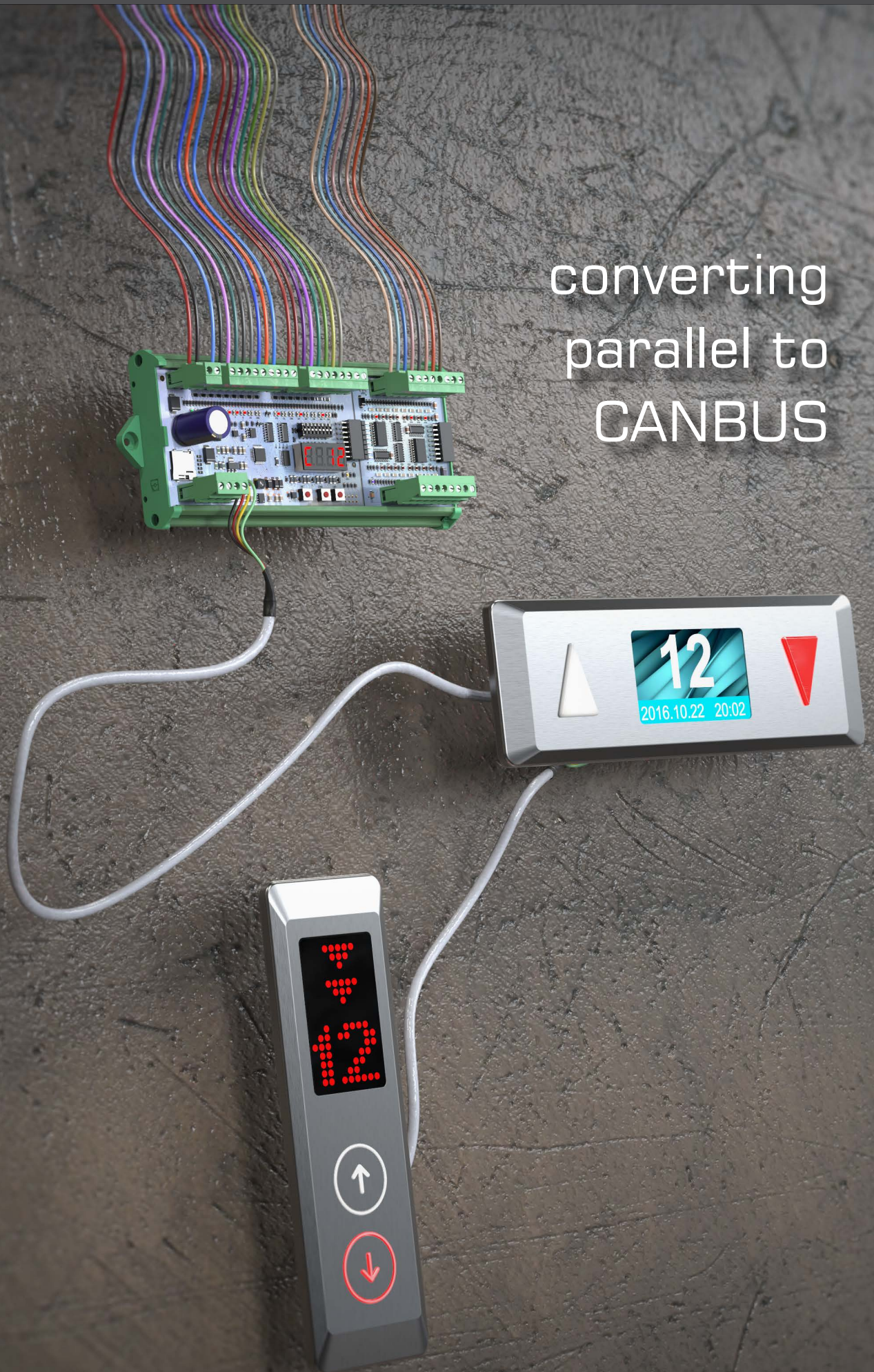

converting
parallel to
CANBUS



GV4110



GV41B0



AV1202

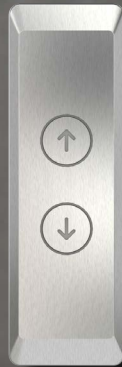

AV2202



GV1012



GV2012



GV1072



GV2072



GV10B2

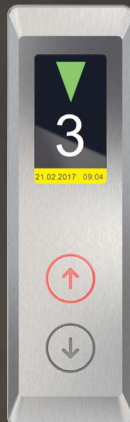

GV20B2

Color TFT AVOX



731.CT4

732.CT4

733.CT4

73F.CT4

93F.CT4

Color TFT AVOX

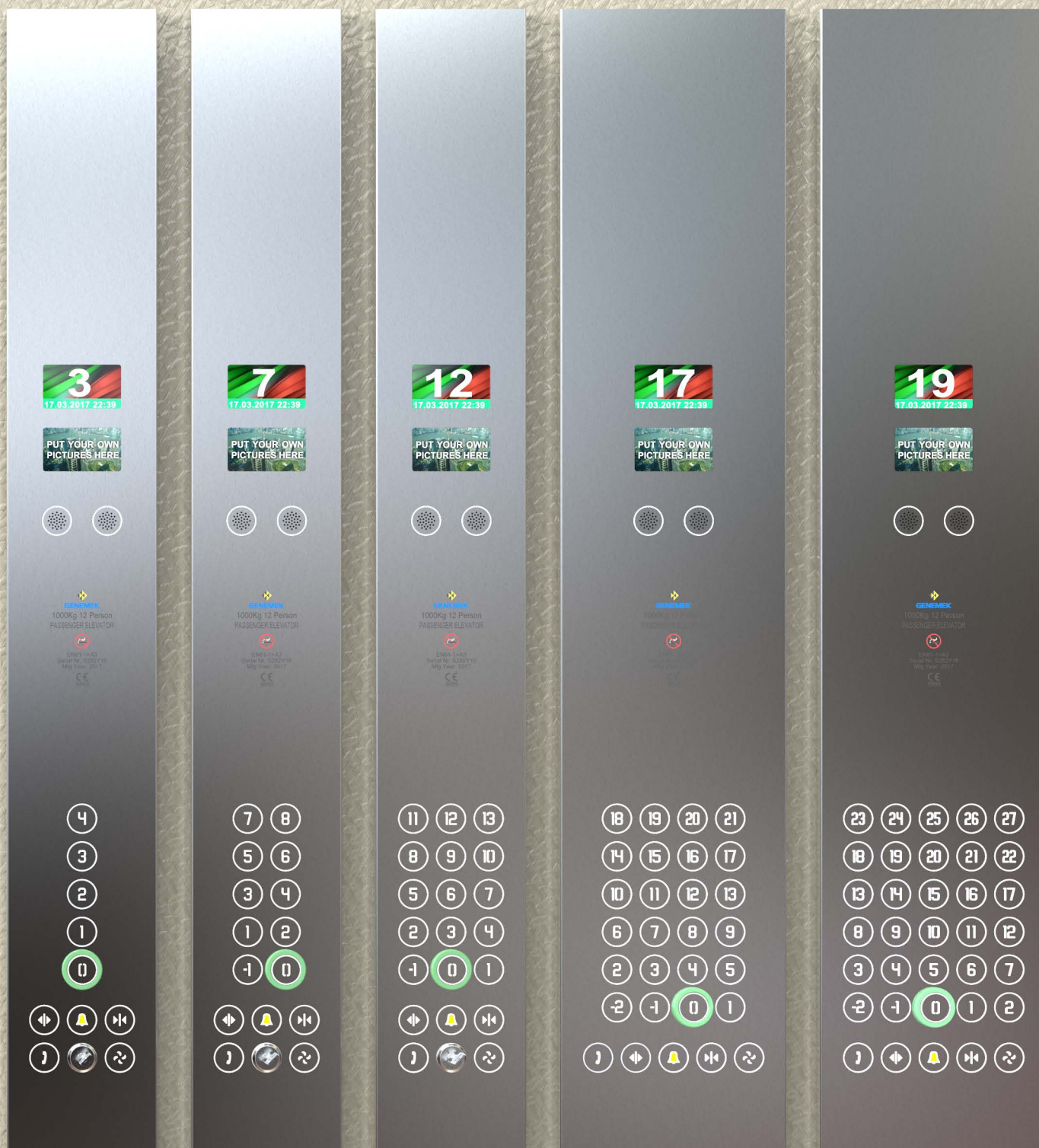

931.CT4

932.CT4

933.CT4

954.CT4

955.CT4

REDLINE LOP

**ultra thin
surface mounted**

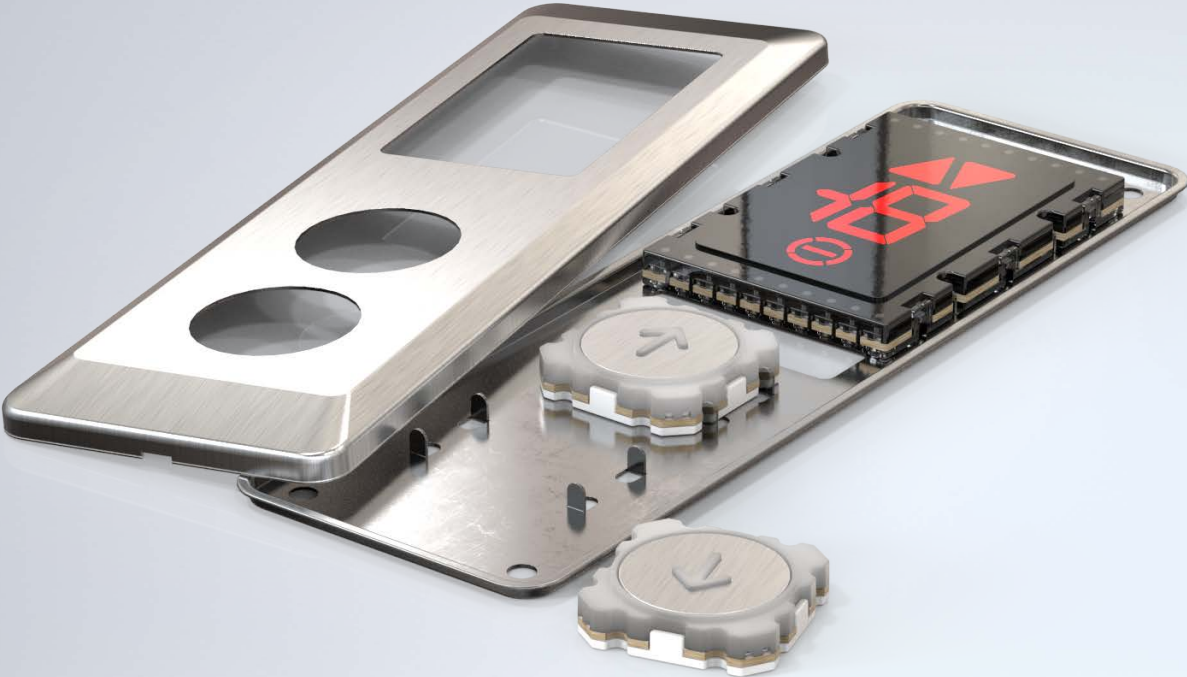

AV1002



AV1072



AV1082

REDLINE LOP

AV4070



AV3070



9.9
mm
AVOX



AV2082



AV2072



AV2002

PROWIRED LOP

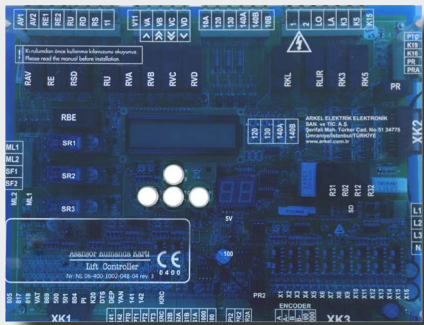

ready to plug



AV-PP2

AV-TSV

AV-PP1

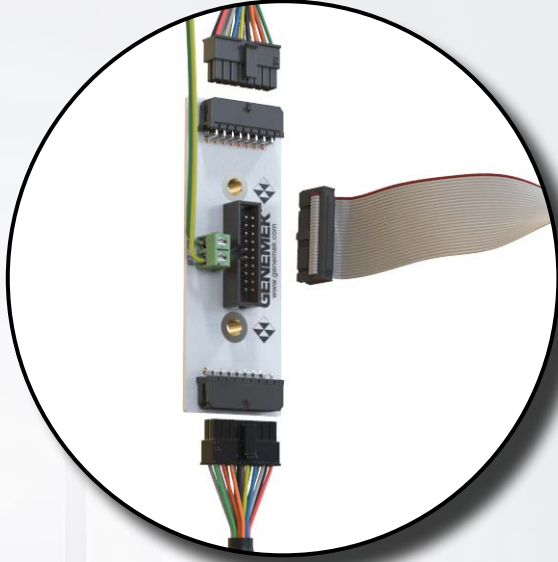

PROWIRED LOP



PW1072



PW1082



PW2072



PW2082

components

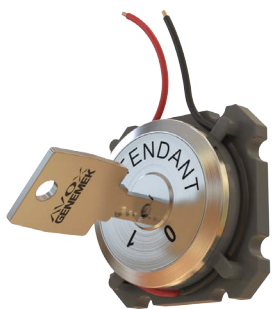

AV-KSW
keyswitch



AV-DKL
decorative surface



AV-FM2
LASER marking

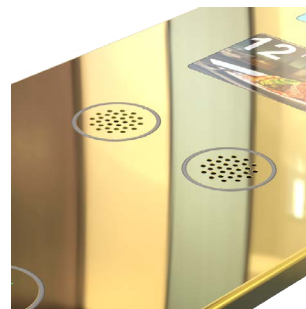

AV-DKC
decorative surface



AV-FM1
LASER marking



AV-BLF
color printed film



AV-BLH
high-contrast
printed film

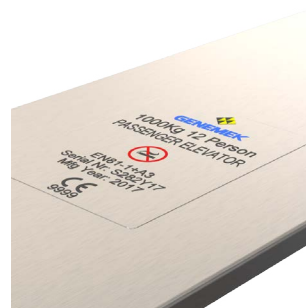

AV-FMU
ultra violet
color printing



AV-INC
intercom module

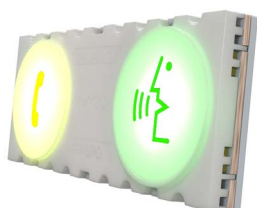

AV-SPD
emergency phone
illuminated icons



AV-INT
two ways
communication
system





black
mirror

black
brushed

gold
brushed

gold
mirror

bronze
mirror

position indicators

indicator options



AV-DSVR

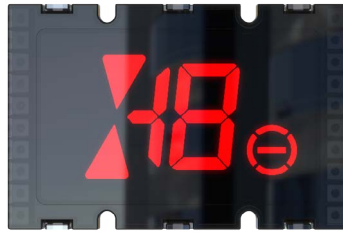

AV-DSHR

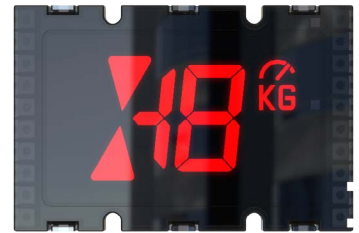

AV-DSCR

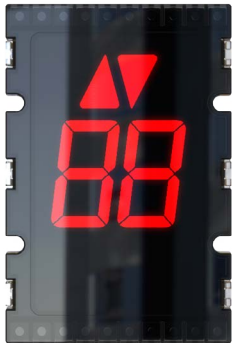

AV-DDVR

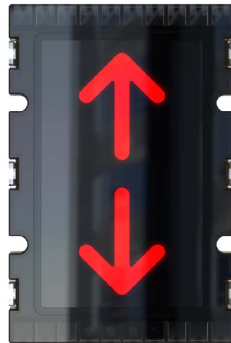

AV-DSAR

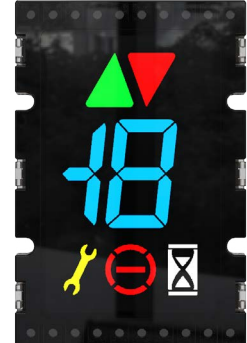

AV-DSVM

emergency light units



AV-EMG



AV-EMS

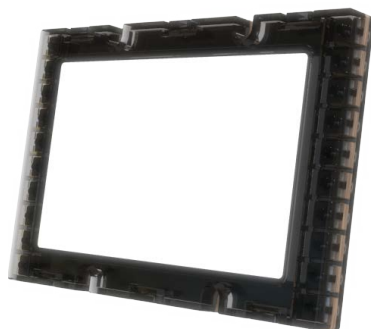

AV-BLT



button options

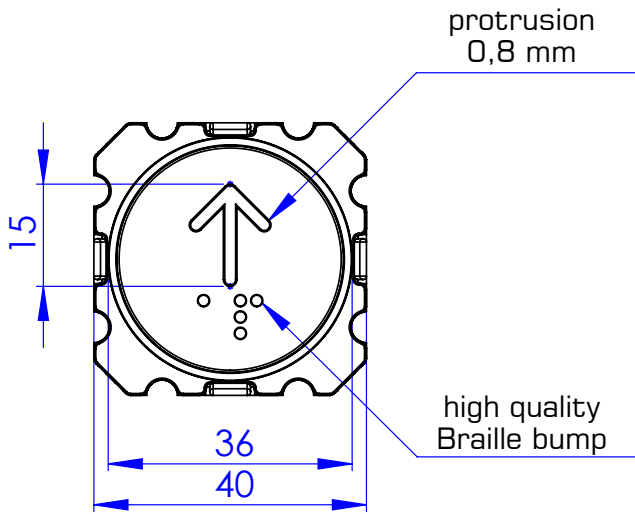

AV-BTR



AV-BBD

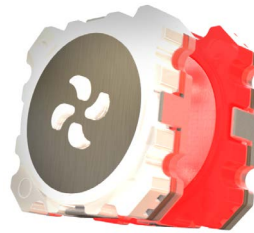

AV-BTD



AV-BDC

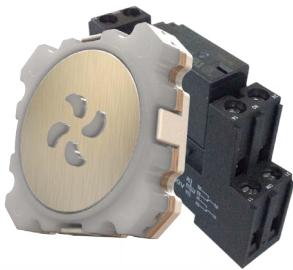

AV-BFA

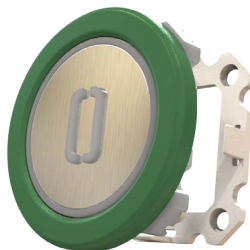

AV-BER



AV-BNC



AV-BSP

combinations



dimensions

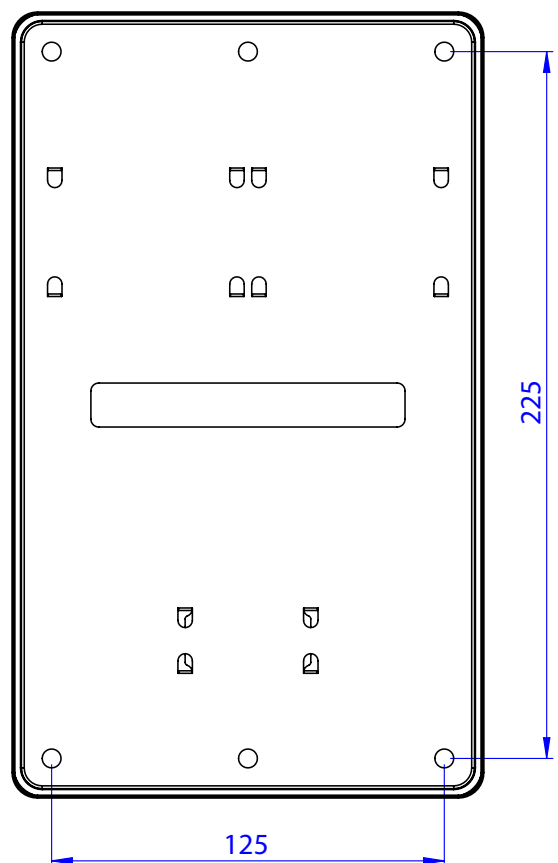
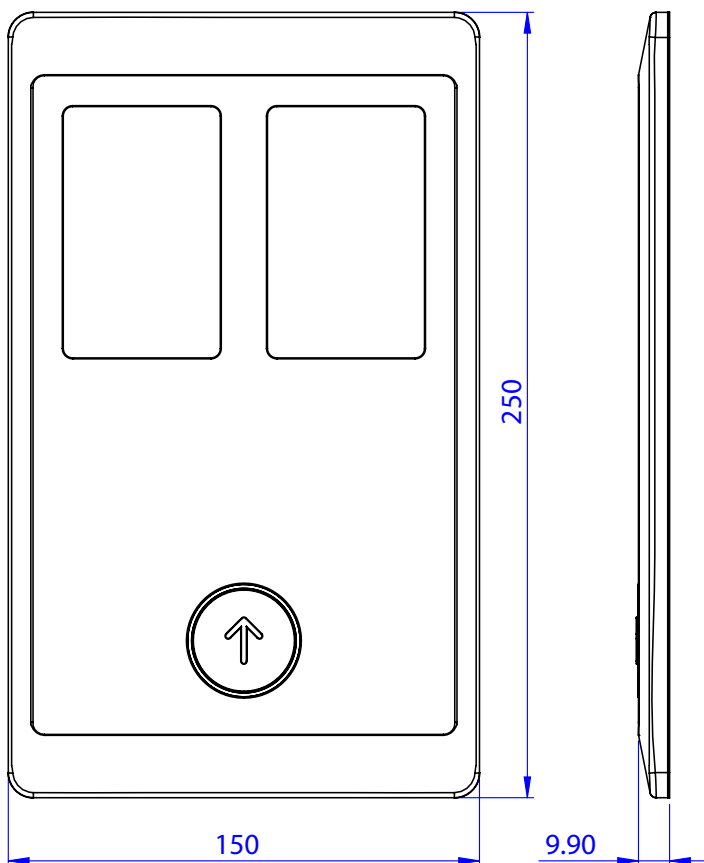
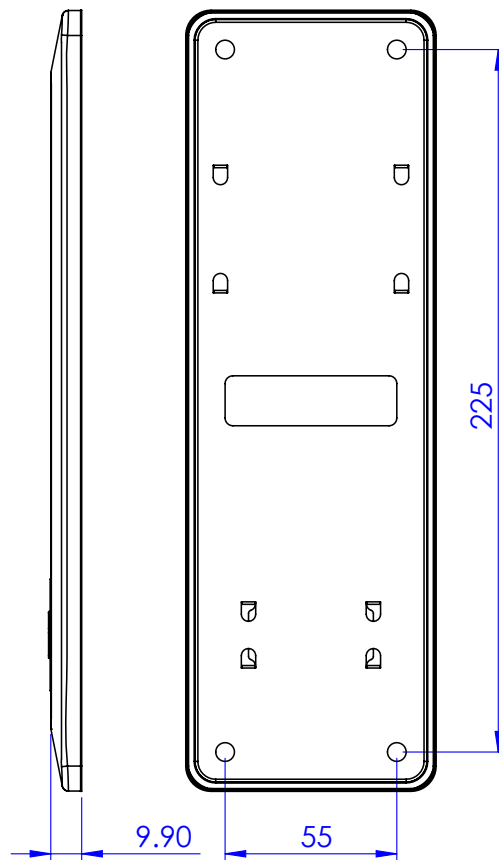
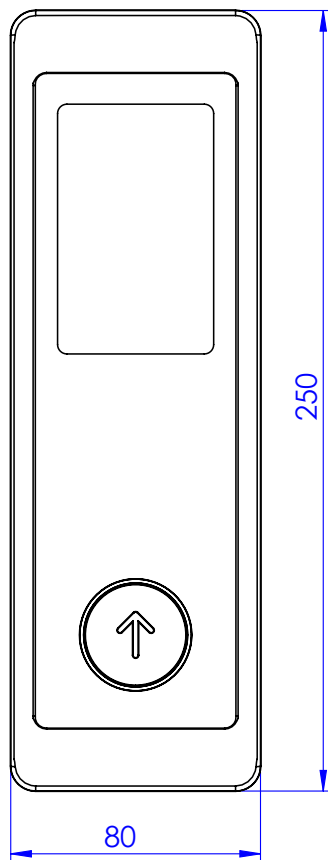

available figures

non-Braille figures

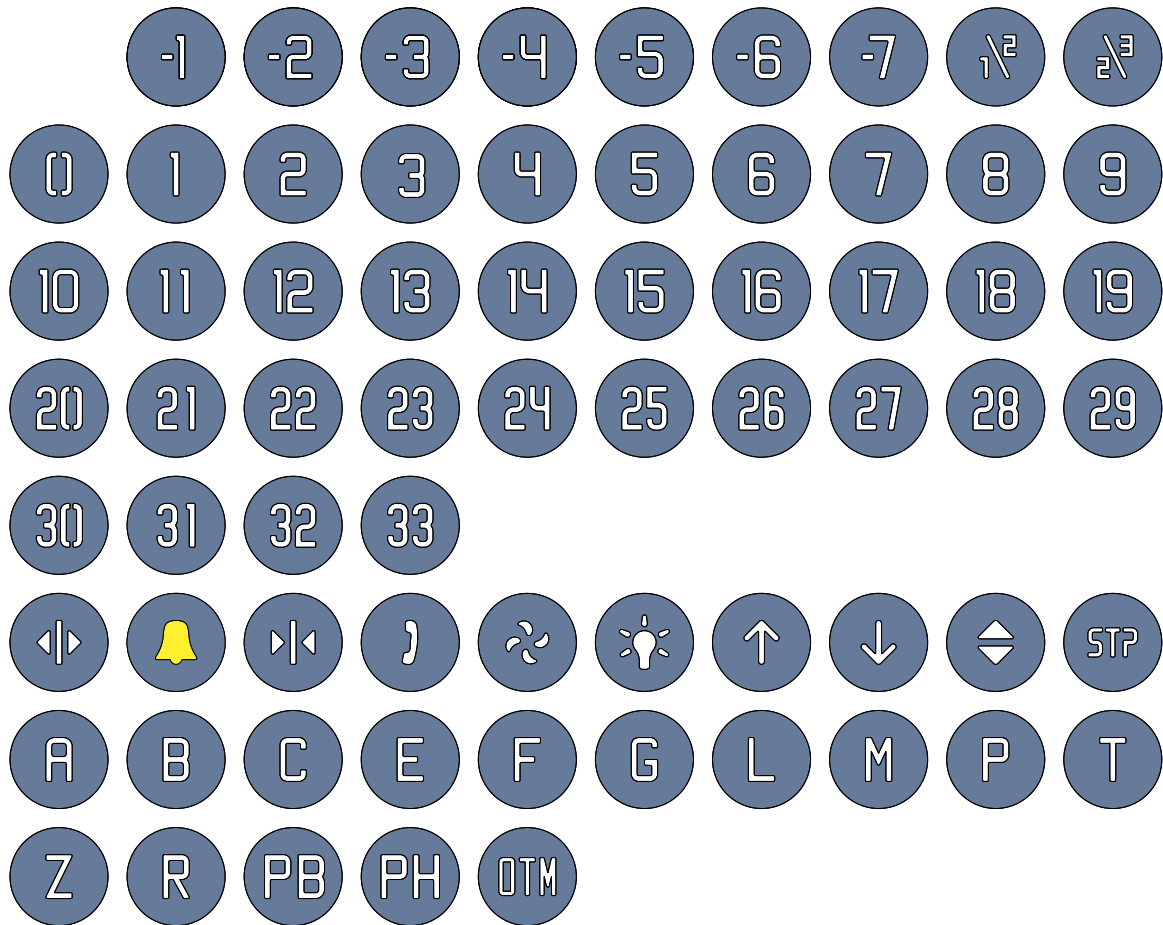

Braille coded figures

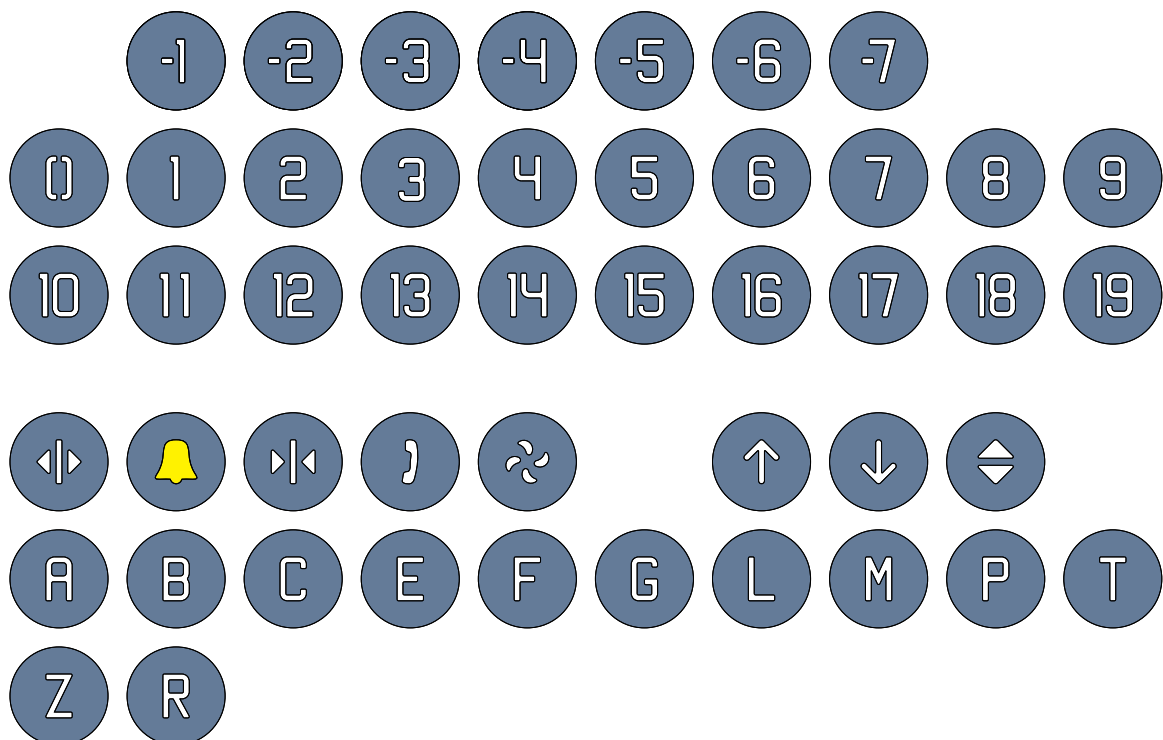

HERA COP



HR721.DX2



HR721.DX2



HS721.PKD

MONO COP



MN722.USM



MN641.USM

RAM



INTERCOM

two-ways
communication
system







AR4070



AR4030



AR4010



AR3070



AR3030

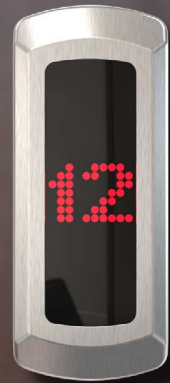

AR3010



AR1006

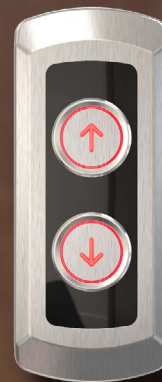

AR2006



AR1076



AR1036



AR1016

RACE



RACE



RC4070



RC4030



RC4010



RC3070



RC3030



RC3010

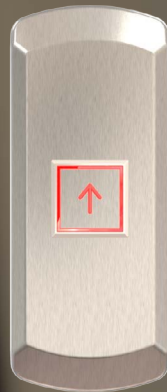

RC1001

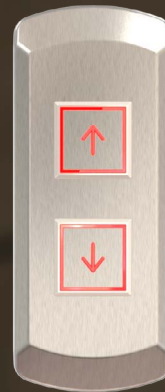

RC2001



RC1071



RC1031



RC1011

MONO LOP



MONO LOP



MN4070



MN4030



MN4010



MN3070



MN1001



MN3030



MN2001



MN3010



MN1081



MN1021



MN1041



MN1031



MN1011



MN1071



MN2081



MN2021



MN2041



MN2031



MN2011



MN2071





EC4070

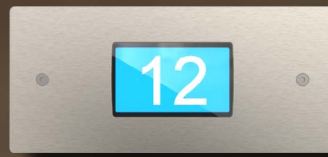

EC4030



EC4010



EC3070



EC1001

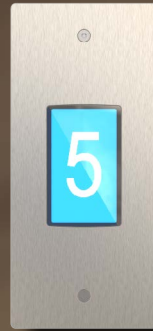

EC3030



EC2001



EC3010



EC1081



EC1021



EC1041

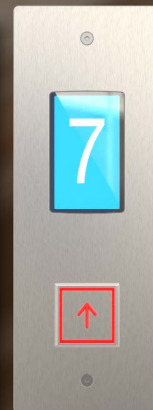

EC1030



EC1011



EC1071



EC2081

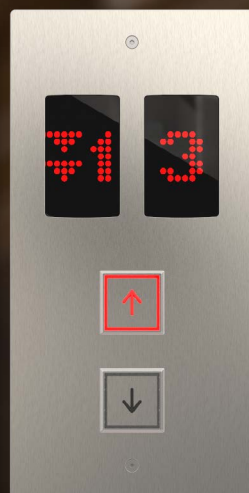

EC2021

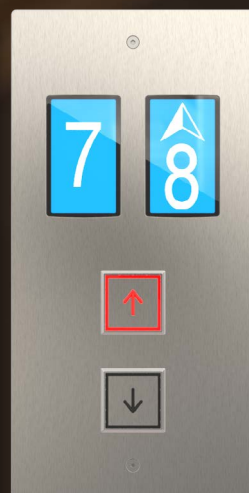

EC2041

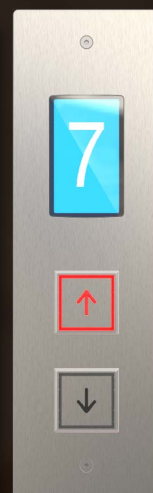

EC2031



EC2011



EC2071

QUAD

premium quality
push buttons

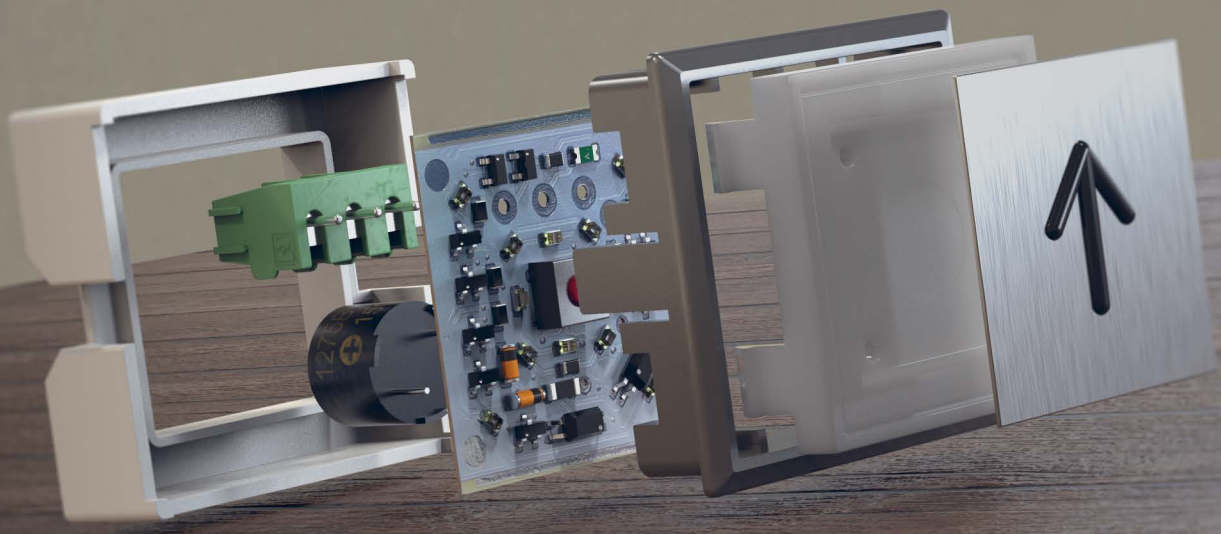



protruded figures



dual contact alarm

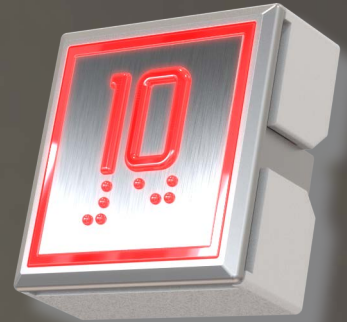

Braille coded



green extruded



keyswitch



emergency lamp

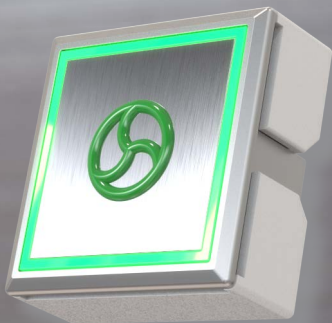

on/off timer



buzz on overload

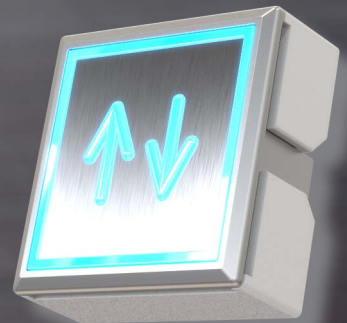

dual color

available figures

0	1	2	3	4	5	6	7	8	9	◀▶	▶▶	↑	↑↓	↓	🔔	↶	STP	⊗	
10	11	12	13	14	15	16	17	18	19	A	B	B1	B2	B3	B4	Ç	EG	G	GF
20	21	22	23	24	25	26	27	28	29	G1	G2	G3	G4	K	L	LL	M	P	PG
30	-1	-2	-3	-4	-5	-6	-7	P1	P2	P3	P4	R	S	SF	T	UG	Z		

LCD graphics indicators

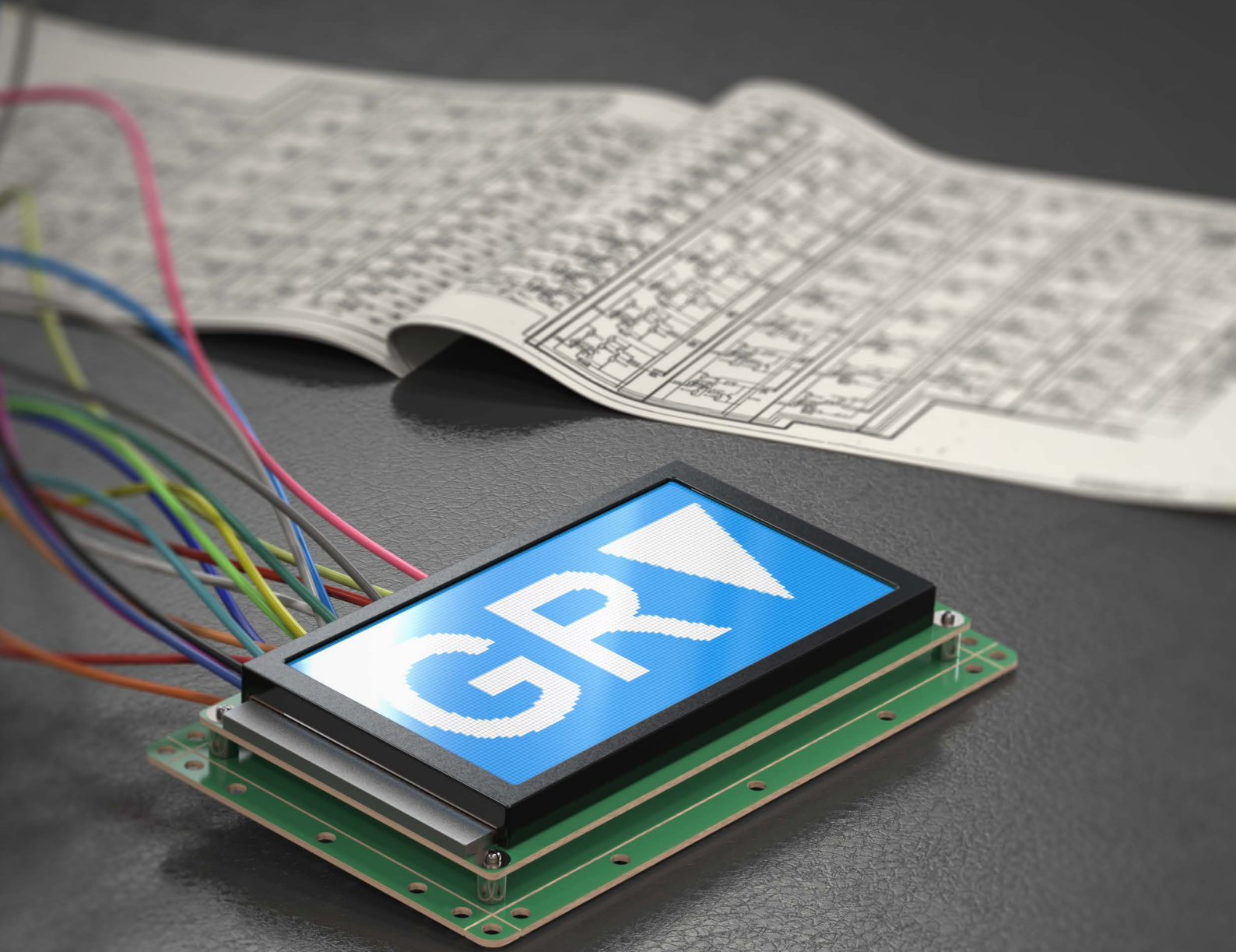

programmable
LCD indicators

LCD graphics indicators

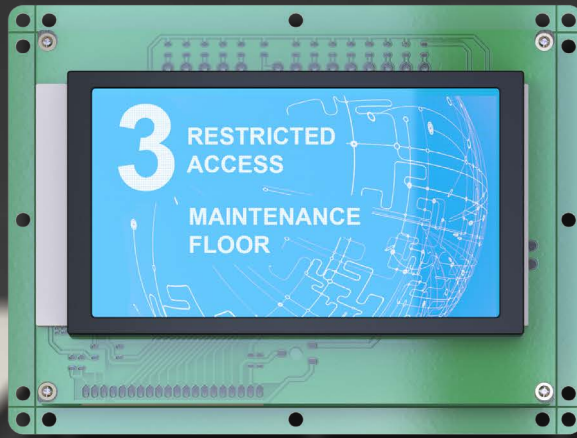

EXCEL



VEGA



DIESEL-2



ULTRASLIM

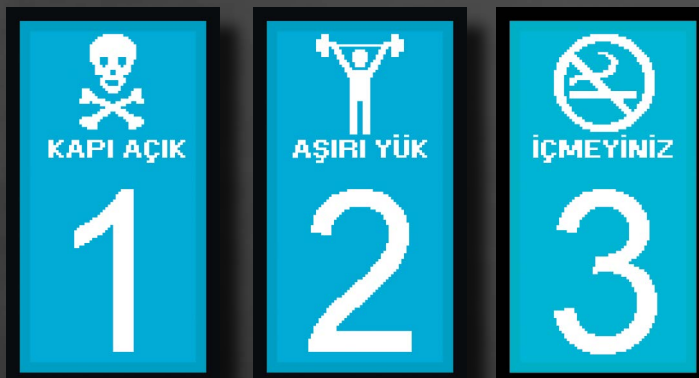

programming software
for graphics LCD indicators

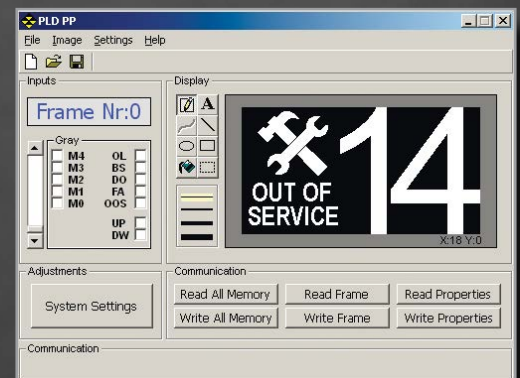

AXES-D



digital security module

LED dot-matrix indicators

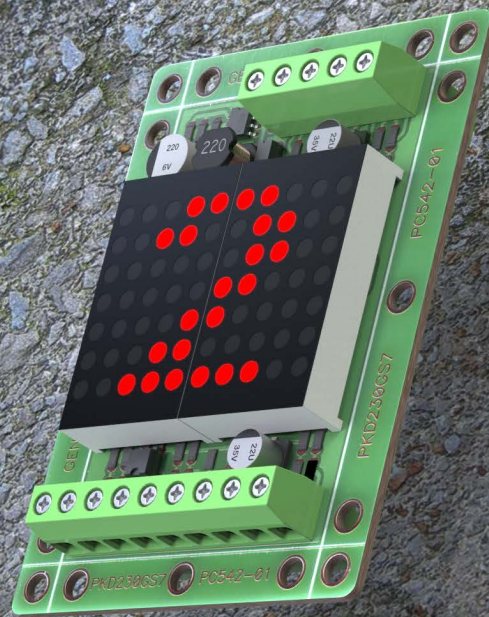

PKD 230GS7



PKD230GS7
switch mode power supply

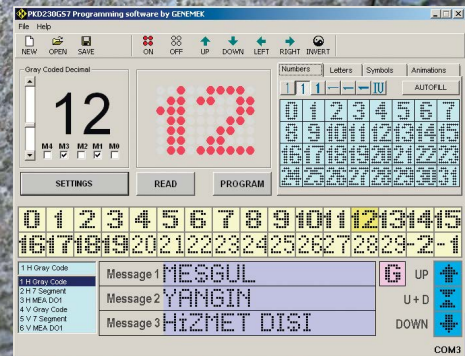

programming software
for dotmatrix indicators



GENEMEK
www.genemek.com

Emek Mah. Ordu Cad. No:6, 34785, Sancaktepe, İstanbul, TURKEY
T: +90 216 365 9242 F: +90 216 365 9244 info@genemek.com